

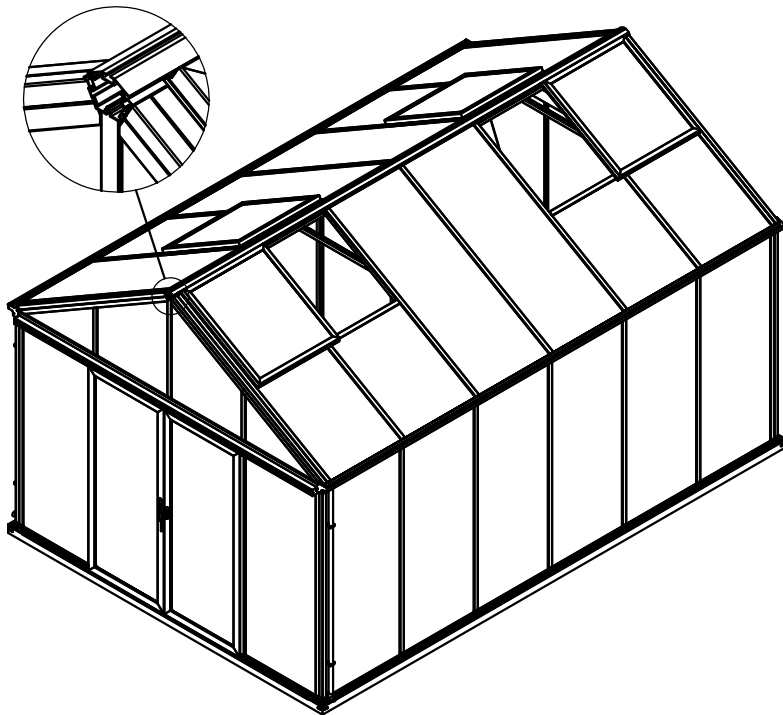

(3111)B

Take off the T09
Ta bort locket T09
Fjern dæksel T09
Fjern deksel T09

Move out the windows.
Skjut takluckorna åt sidan
Skyd tagvinduerne til siden
Skyv takvinduerne til siden

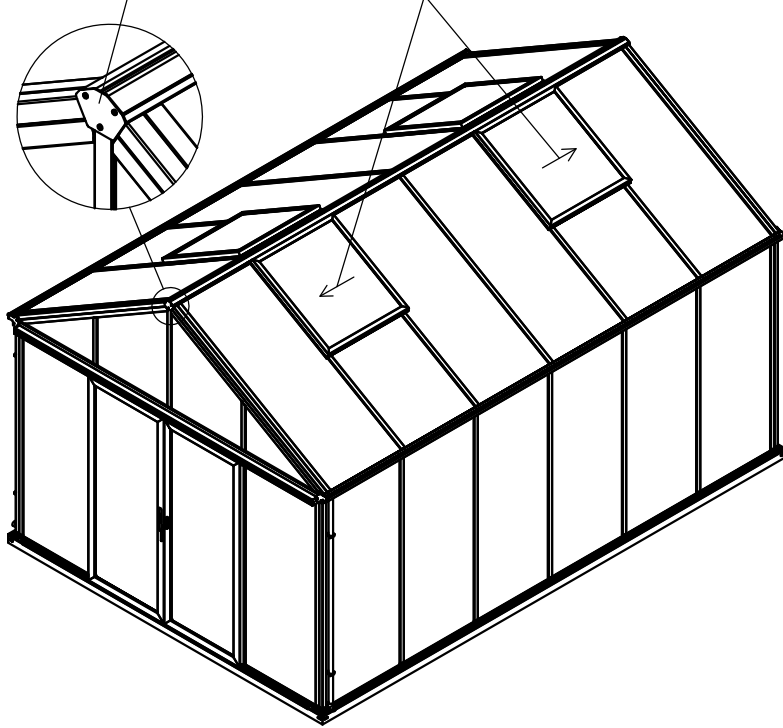

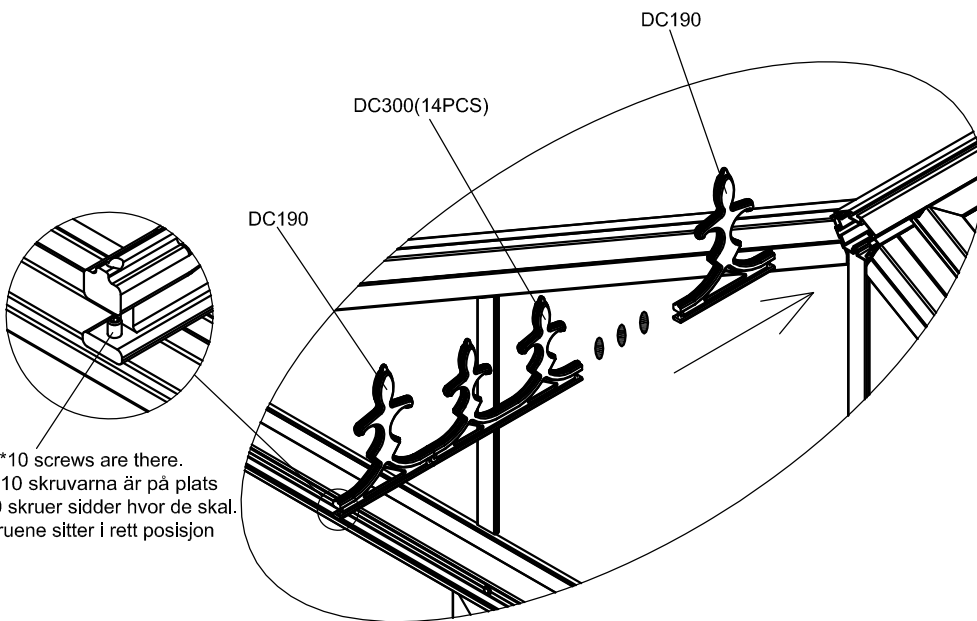

Make sure M4*10 screws are there.
Säkerställ att M4*10 skruvarna är på plats
Undersøg om M4*10 skruer sidder hvor de skal.
Se til at M4*10 skruene sitter i rett posisjon

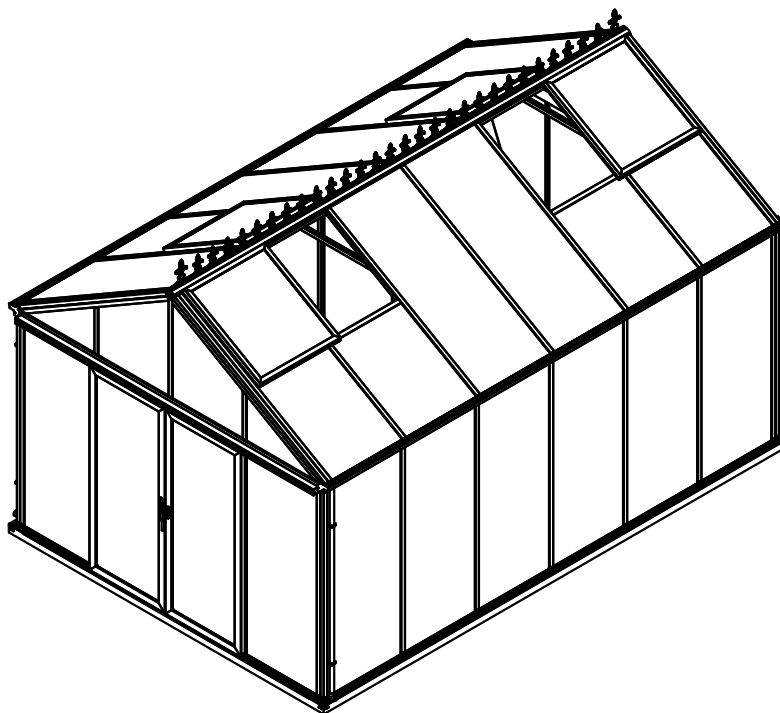

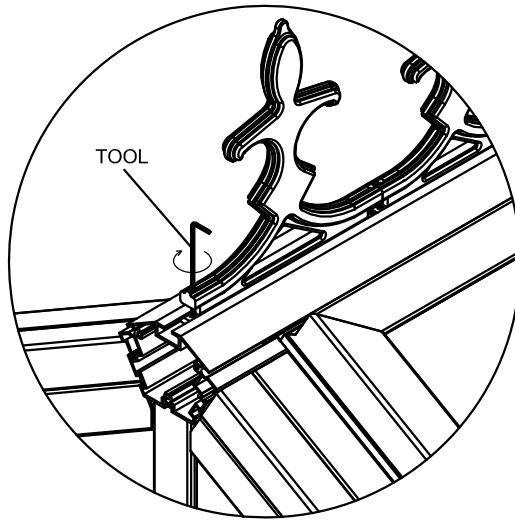

Fix the screws to your wish position.
Fixera delarna och skruva fast dem i rätt position
Fikserer delene og skru dem fast.
Skrue fast skruene i rett posisjon

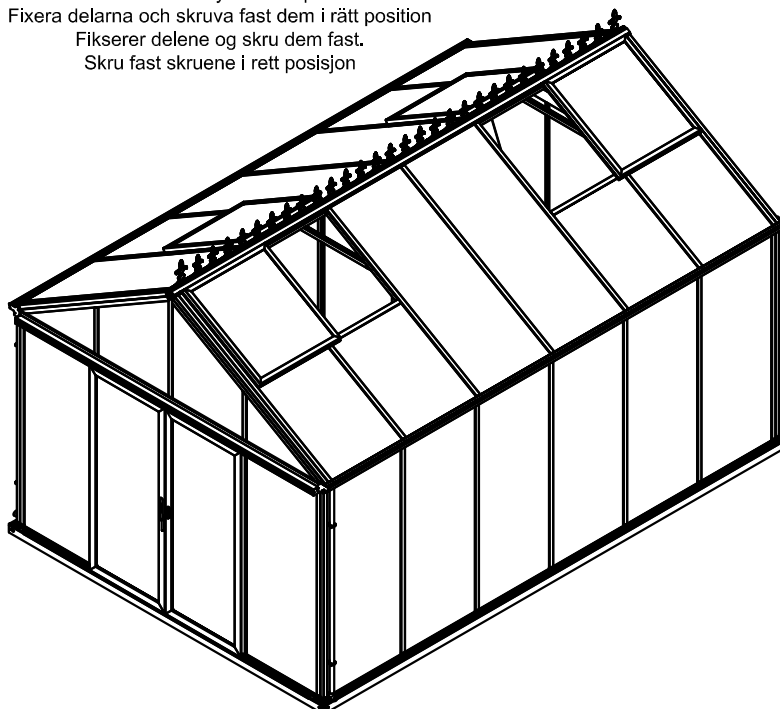

Put back the windows.
Förr tillbaka takluckorna
Træk vinduerne tilbage
Skyv tilbake vinduene

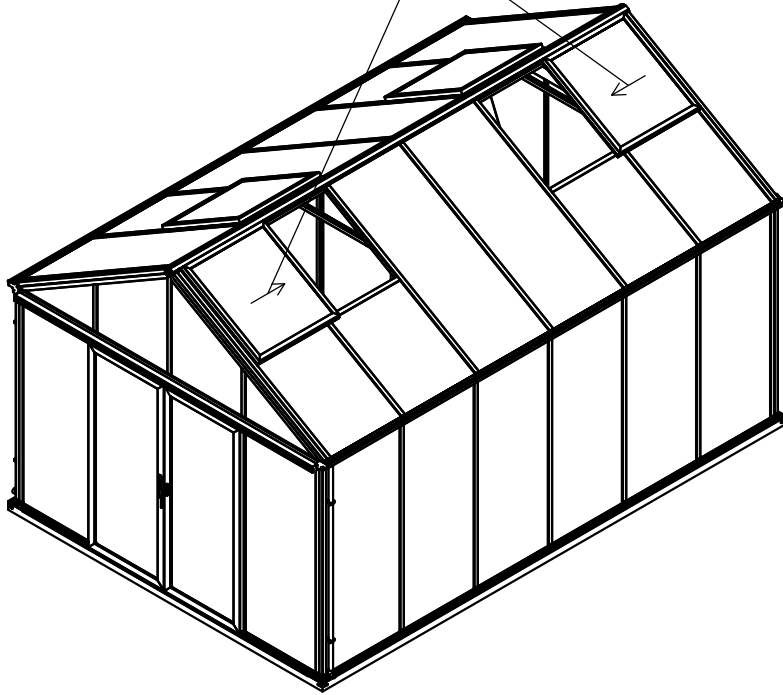

Assemble the T09.
Montera T09
Montere dæksel T09
Skrú tilbake deksel T09

