



Monteringsvejledning

Glasrækværk Aluminium

Indholdsfortegnelse

Før montering	2
Verktug	2
Komponenter	3-5
Tegning	4-5
Montering firkantede stolper	6-7
Montering runde stolper	8-9
Råd om pleje	10

Før montering

- Læs hele monteringsvejledningen, inden du påbegynder monteringen! Hvis anvisningen ikke følges, fungerer produktet måske ikke optimalt, og garantien vil ikke være gældende.
- Willab Garden forbeholder sig ret til at foretage ændringer i materialer, konstruktion og design.
- Kontroller leverancen for at sikre, at den er komplet, og at intet er beskadiget under transporten.
- Skrue til fastgørelse i underlag medfølger ikke. Rådfør dig med en fagmand for at sikre korrekt fastgørelse i underlaget.

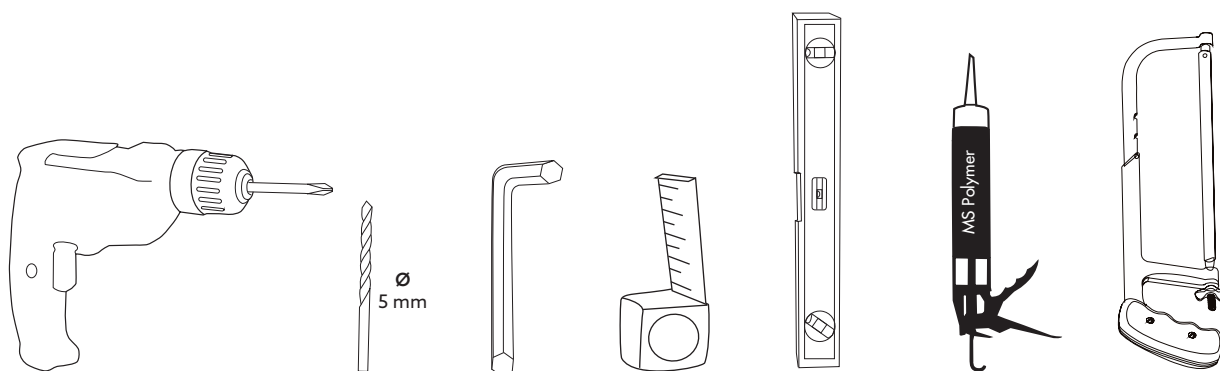

Komponenter

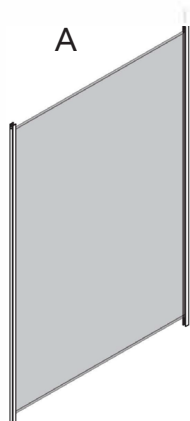

8mm Lamineret Glas
100 x 90,5 cm
741070 / 741040
741079 / 741049

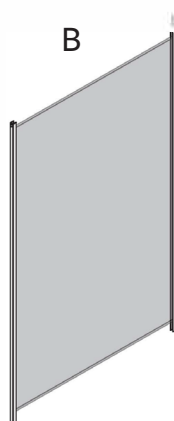

8mm Lamineret Glas
90 x 90,5 cm
741970 / 741940
741979 / 741949

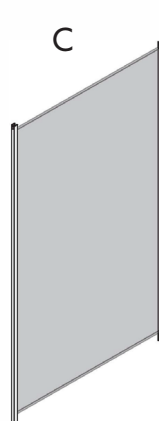

8mm Lamineret Glas
80 x 90,5 cm
741870 / 741840
741879 / 741849

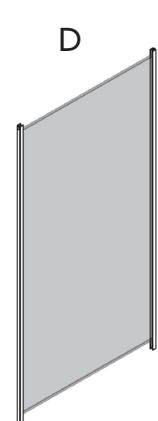

8mm Lamineret Glas
70 x 90,5 cm
741770 / 741740
741779 / 741749

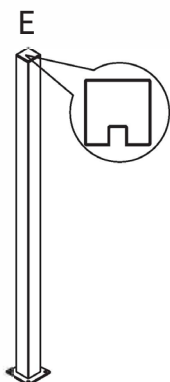

Endestolpe
50 x 50 x 990 mm
742071 / 742041

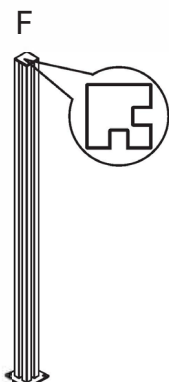

Hjørnestolpe
50 x 50 x 990 mm
742073 / 742043

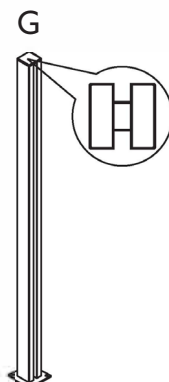

Mellemstolpe
50 x 50 x 990 mm
742072 / 742042

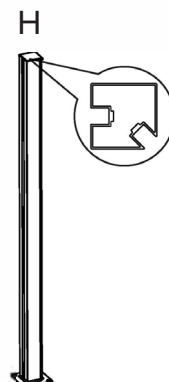

Hjørnestolpe 45°
50 x 50 x 990 mm
742075 / 742045

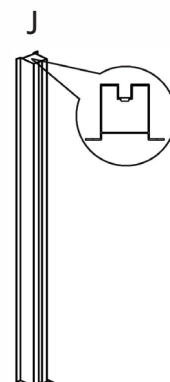

Endestolpe til vægttilslutning
50 x 80 x 990 mm
742074 / 742044

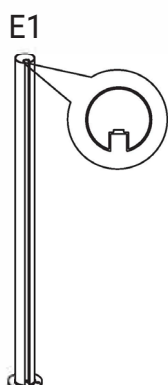

Endestolpe
50 x 50 x 990 mm
744071 / 744041

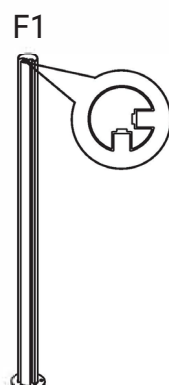

Hjørnestolpe
50 x 50 x 990 mm
744073 / 744043

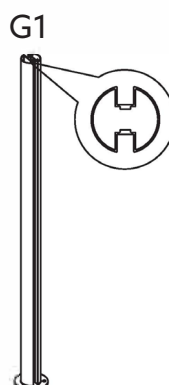

Mellemstolpe
50 x 50 x 990 mm
744072 / 744042

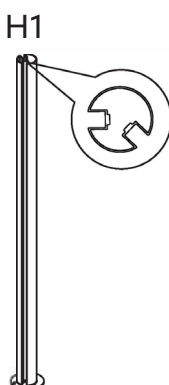

Hjørnestolpe 45°
50 x 50 x 990 mm
744075 / 744045

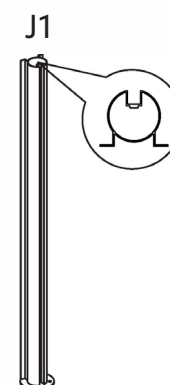

Endestolpe til vægttilslutning
50 x 80 x 990 mm
744074 / 744044

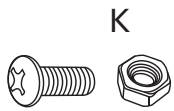

M4 x 10 mm
M4 Bult

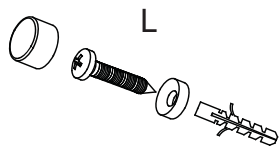

ST4 x 35 mm



Ø4.2 mm

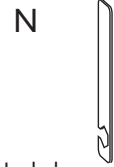

Nykel

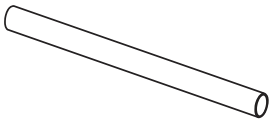

Overligger Længde 101 cm
743071 / 743041 / 743081

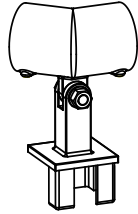

Hjørneholder til overligger
45°
743077 / 743047

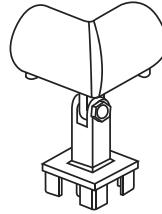

Hjørneholder til overligger
90°
743076 / 743046

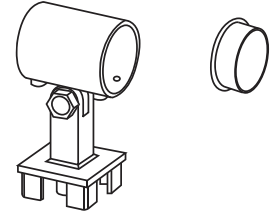

Lige holder med endehætte
743075 / 743045

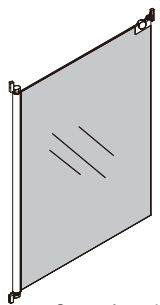

8mm Lamineret Glaslåge
900 x 905 mm
741140 / 741170
741149 / 741179

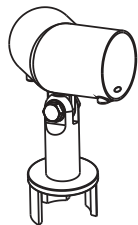

Hjørneholder til overligger
45°
745077 / 745047

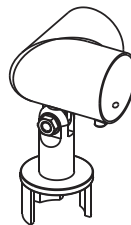

Hjørneholder til overligger
90°
745076 / 745046

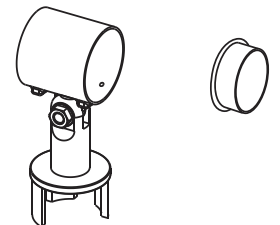

Lige holder med endehætte
745075 / 745045

- Glasrækværkets overligger skal tilskæres cc -10 mm fra stolpen.

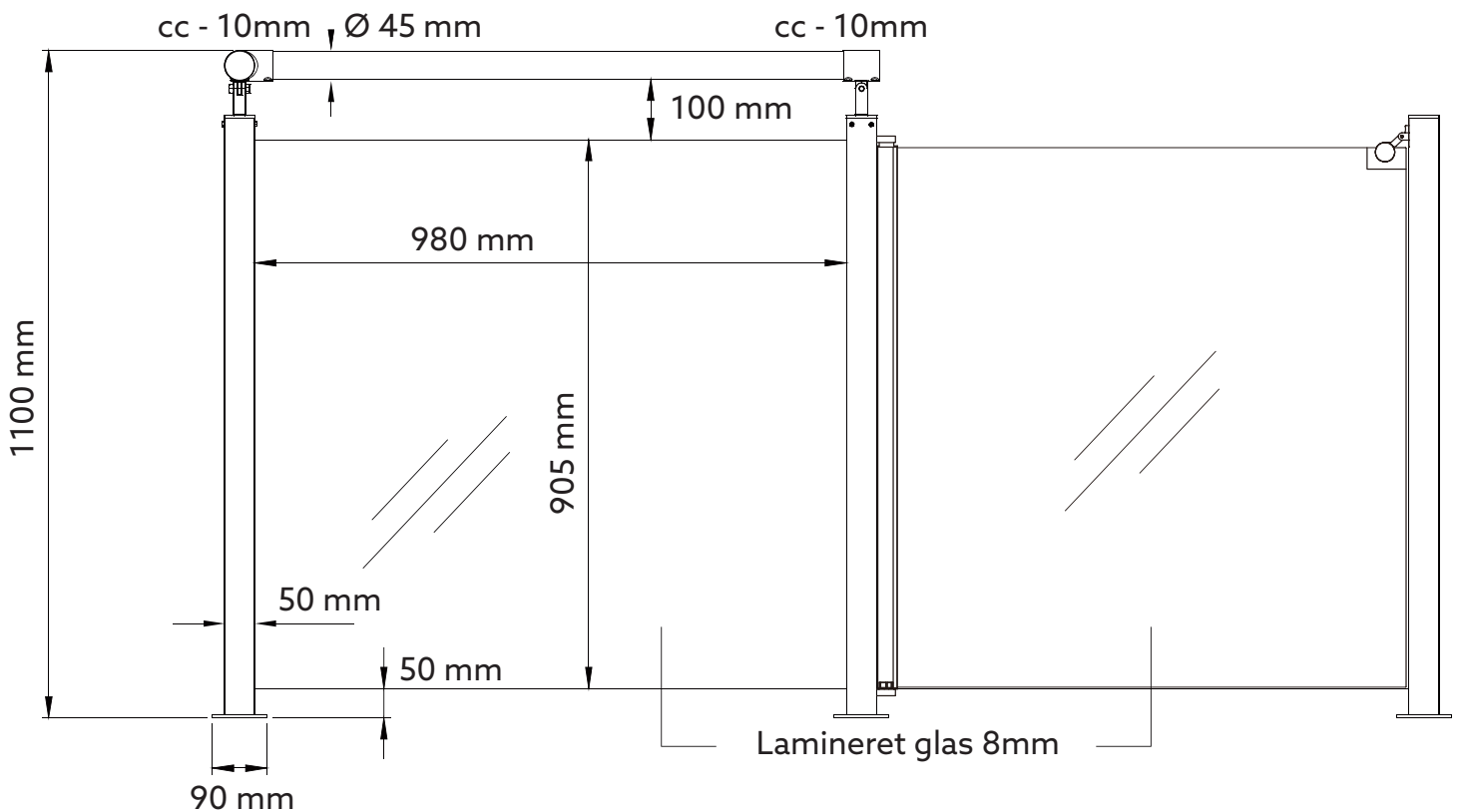

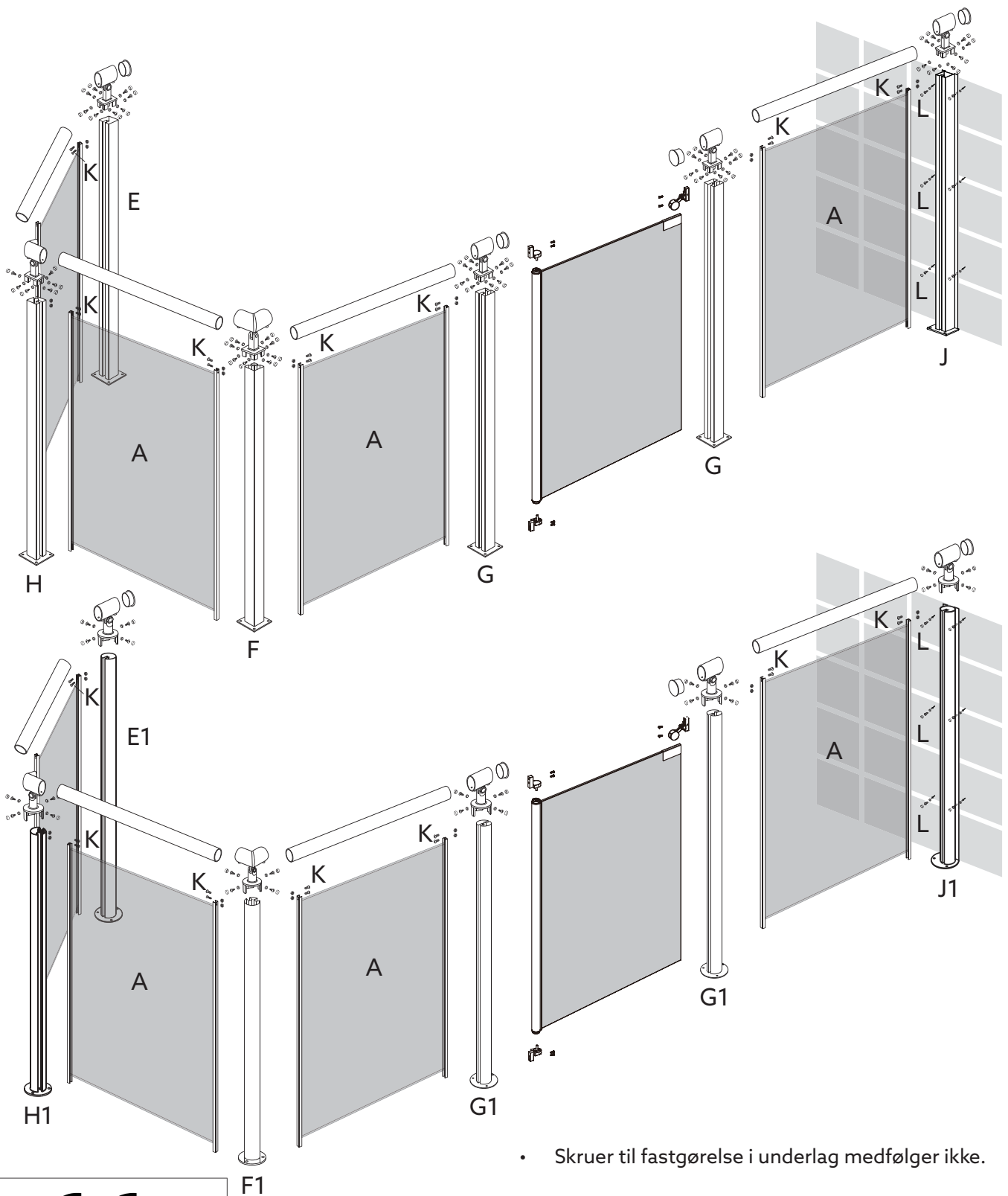

- Skruer til fastgørelse i underlag medfølger ikke.

CE	
<small>GUANGZHOU HUAFENG SAFETY GLASS CO., LTD NO. 68, BIG BRIDGE STREET, XILANG, LIWAN DISTRICT, GUANGZHOU P.R. CHINA</small>	
14	
<small>EN 14449 Laminated glass, intended to be used in buildings and shower enclosure</small>	
Characteristics	
Resistance to fire	: NPD
Reaction to fire	: A1
External fire performance	: NPD
Bullet resistance	: NPD
Explosion resistance	: NPD
Burglar resistance	: NPD
Pendulum body impact resistance	: EN 12600 1(B)1
Resistance against sudden temperature changes and temperature differentials	: NPD
Wind, snow, permanent and imposed load resistance	: NPD
Direct airborne sound insulation	: NPD
Thermal properties	: NPD
Radiation properties^[c]1]	: NPD
- Light transmission and reflection	
- Solar energy characteristics	
Declaration of Performance No.	: 001-CPR-201406



Sikkerhedsadvarsel:

- Glasrækværket er kun beregnet til udendørs brug.
- Glasrækværket skal altid fastgøres grundigt i jorden/gulvet.
- Glasrækværket er designet til brug i jordhøjde. Det er ikke beregnet til og må ikke anvendes på ujævnt underlag.

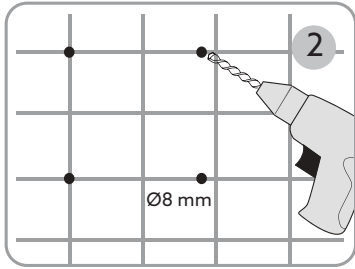
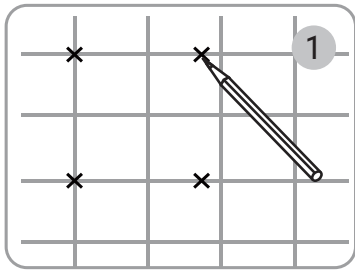

- Skruer til fastgørelse i underlag medfølger ikke.

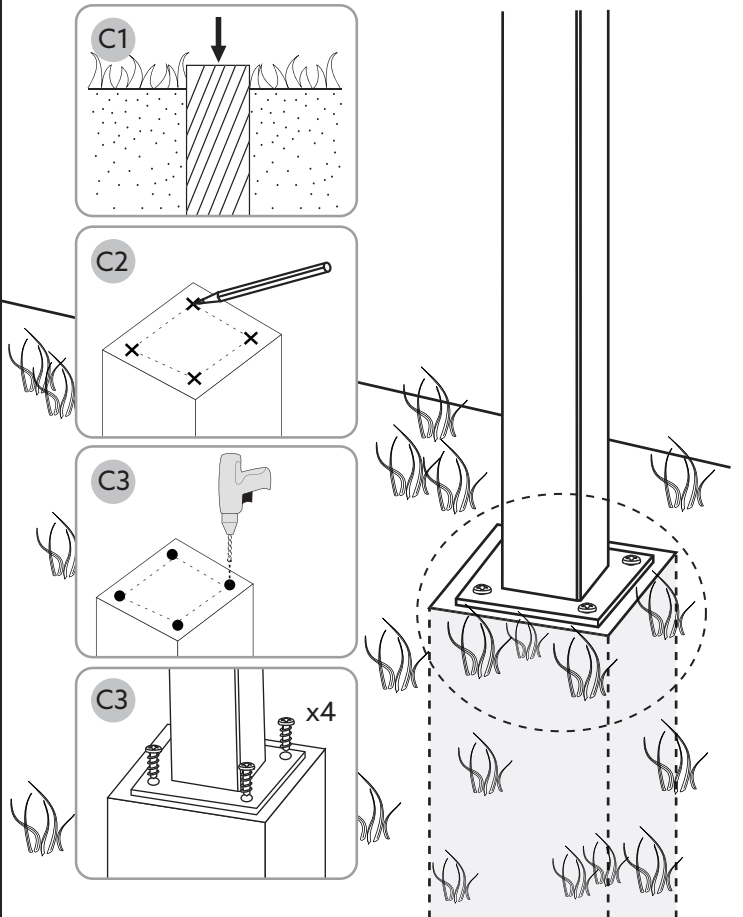
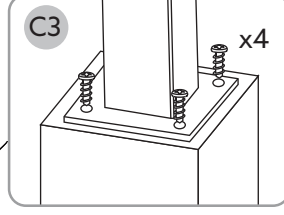
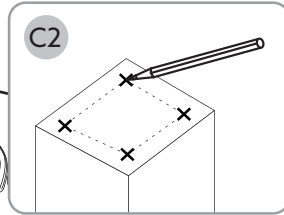
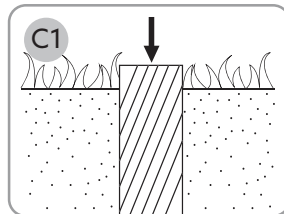
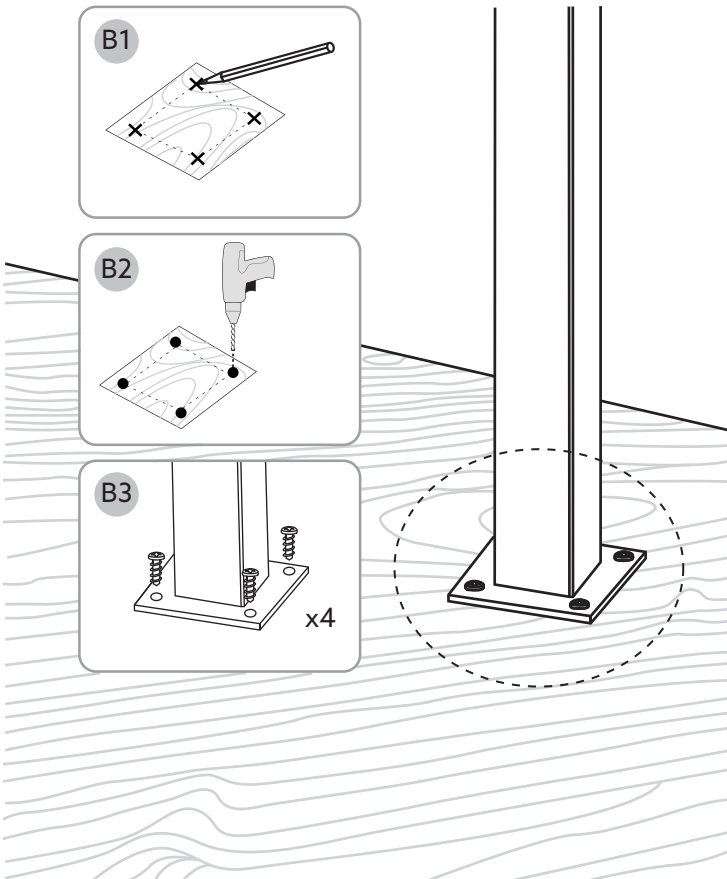
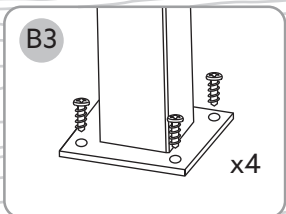
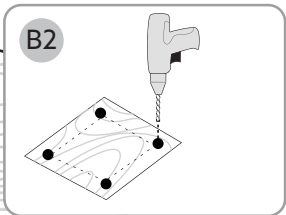
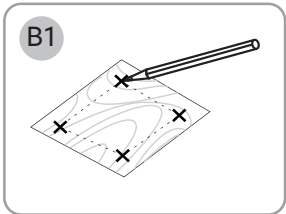
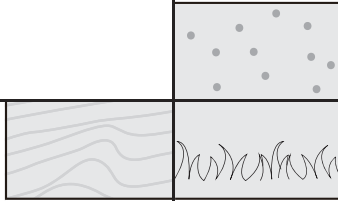
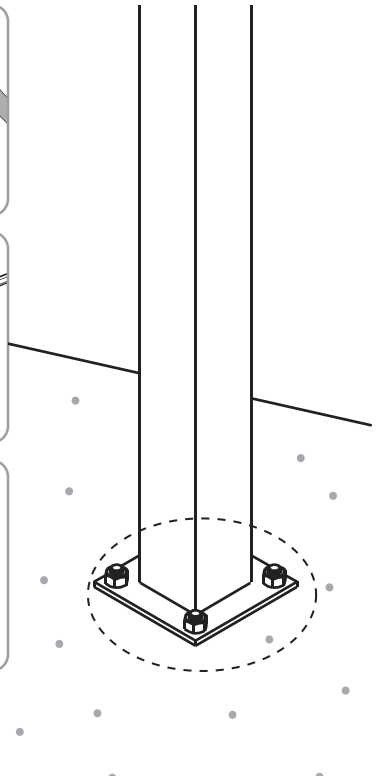
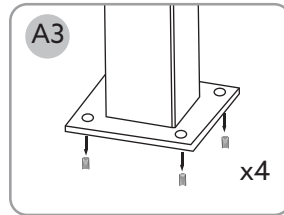
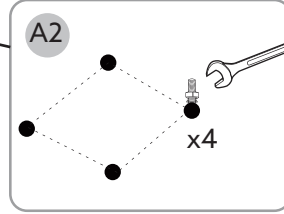
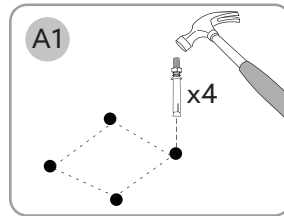
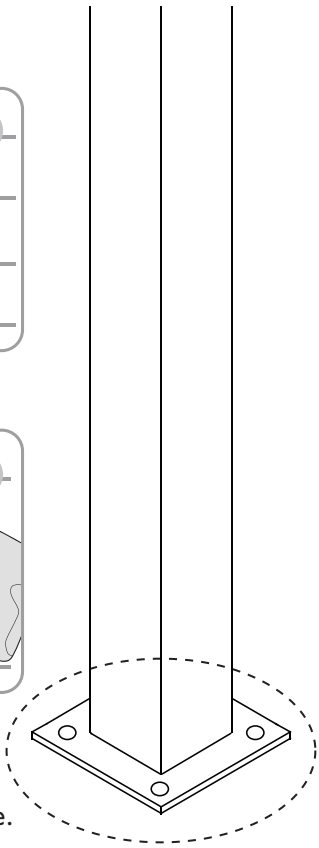

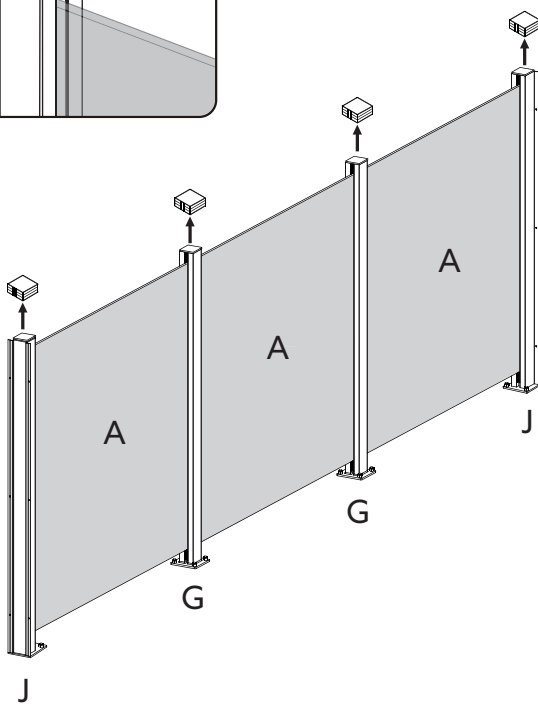
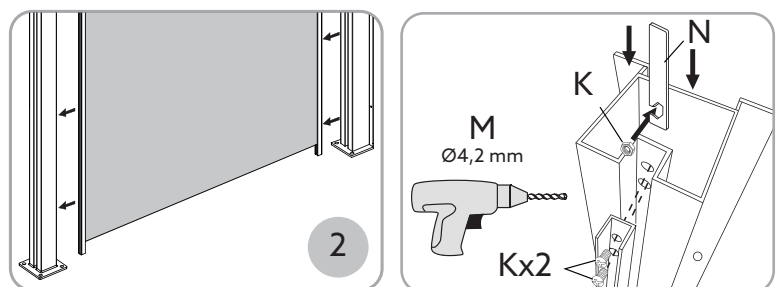
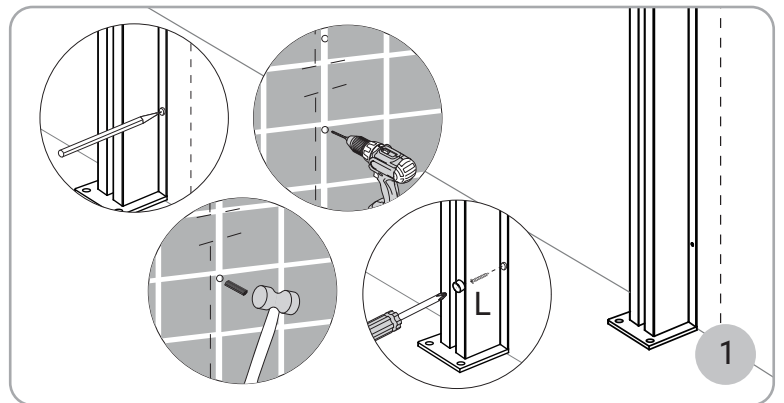
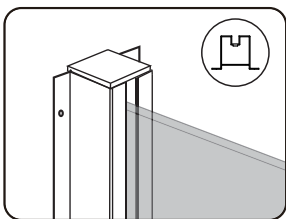
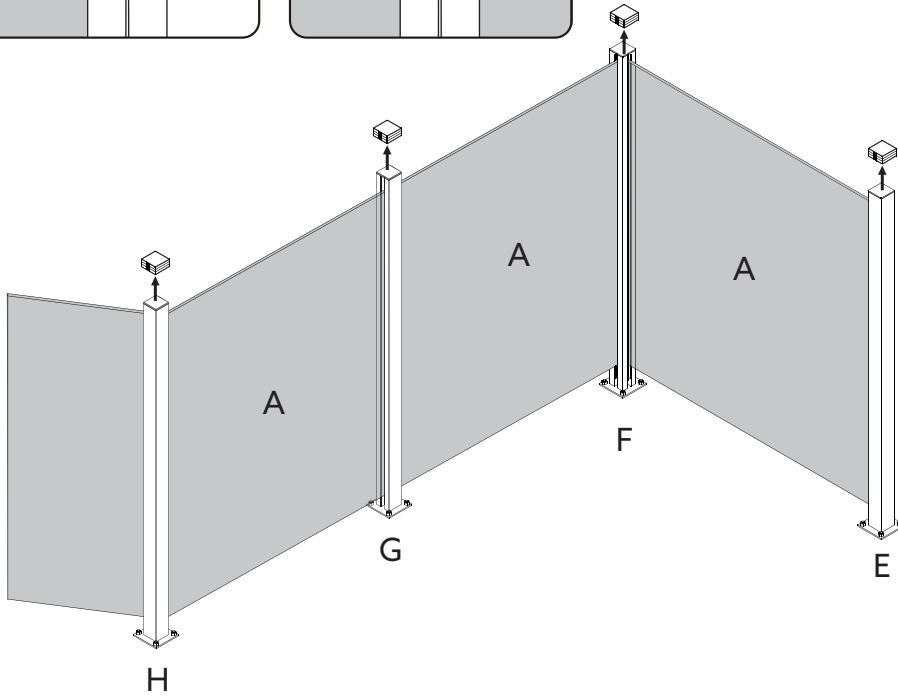
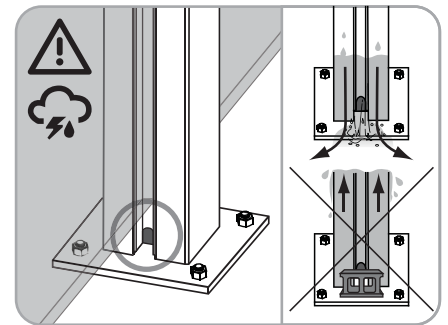
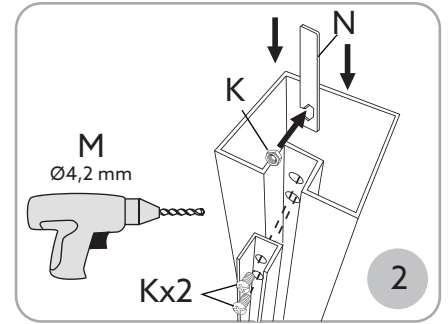
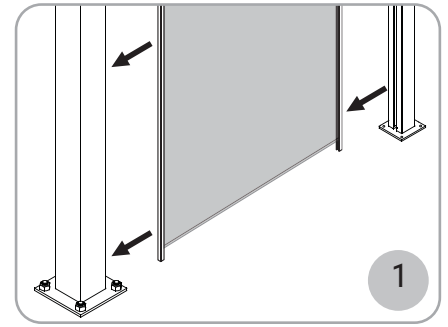
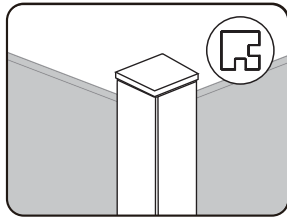
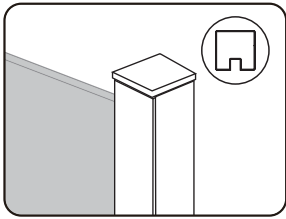
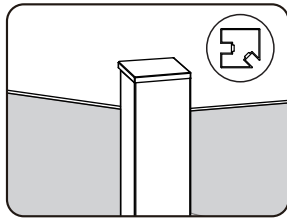
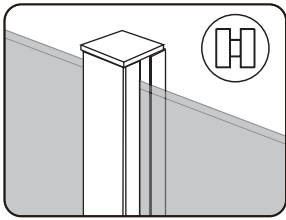

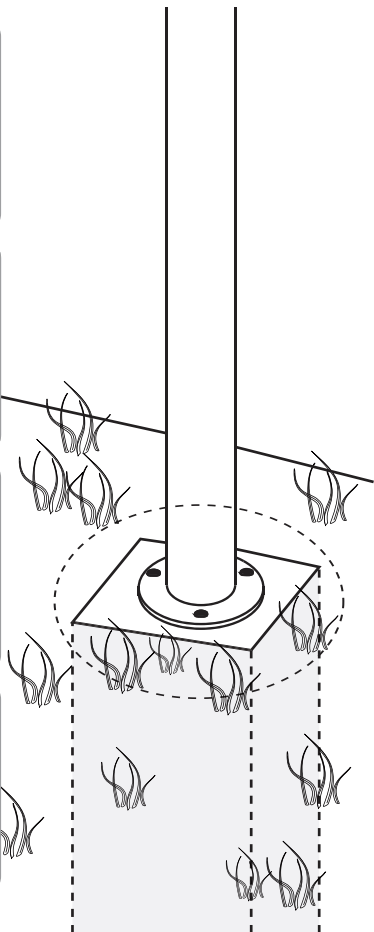
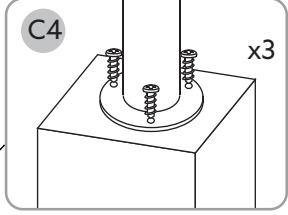
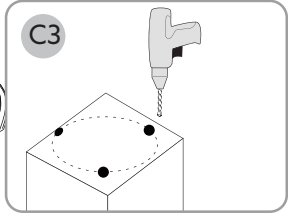
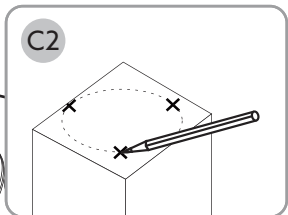
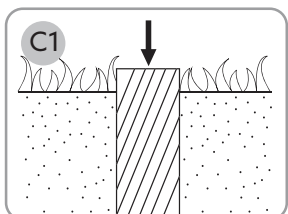
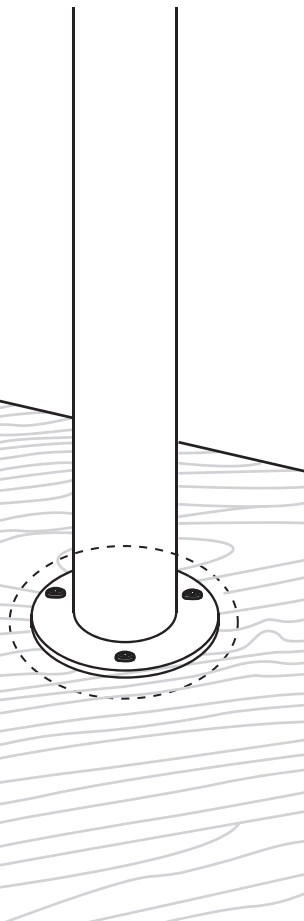
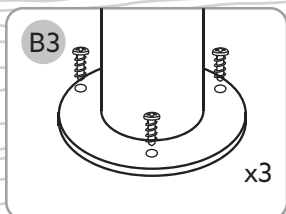
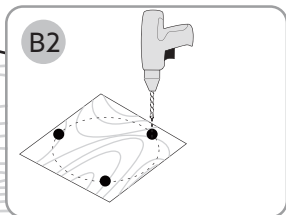
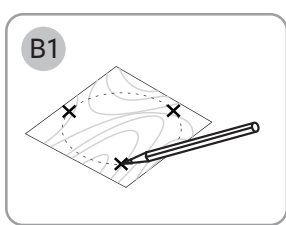
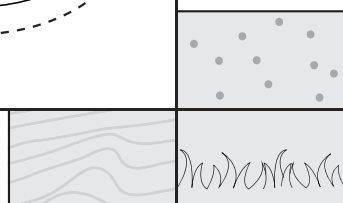
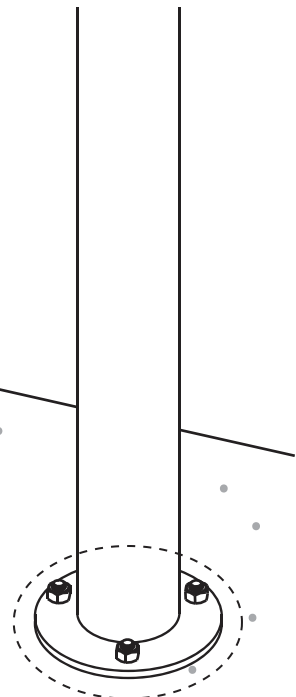
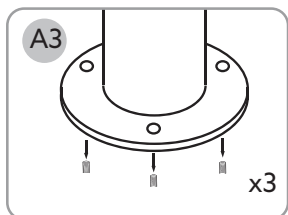
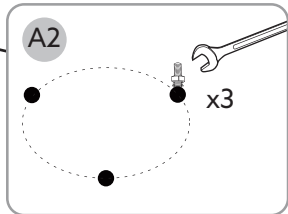
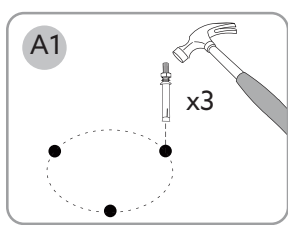
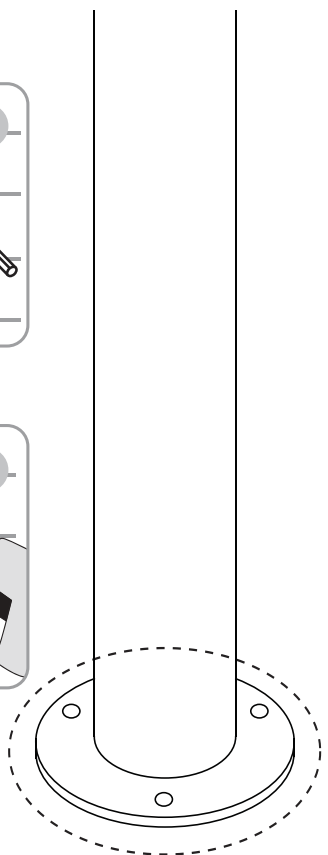
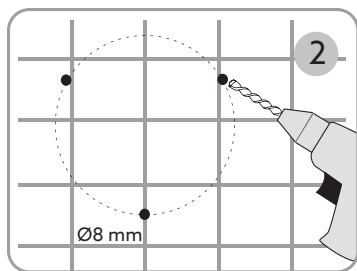
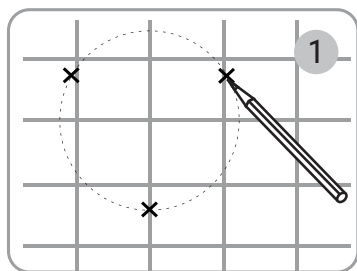

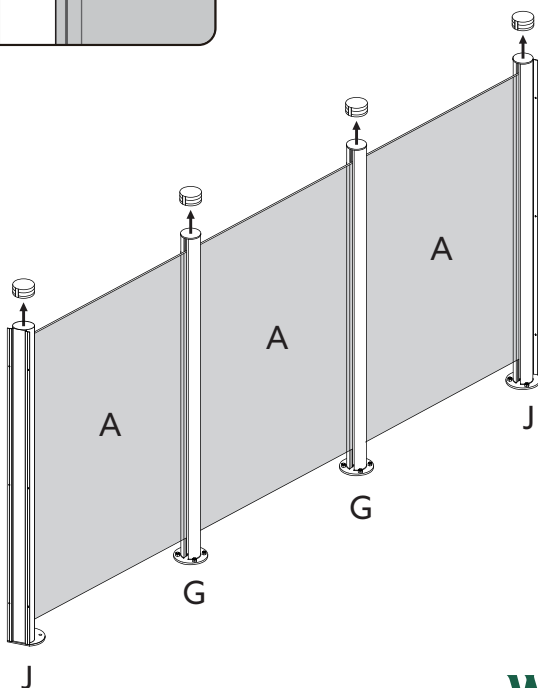
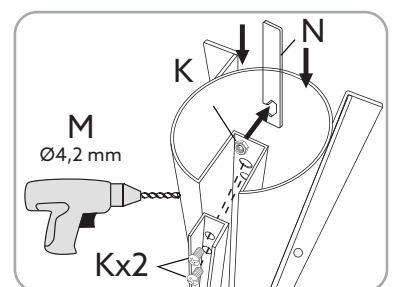
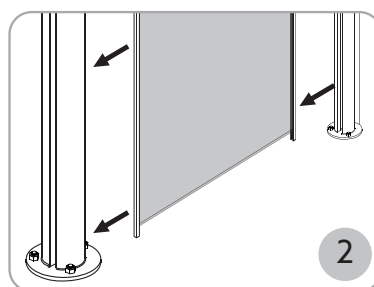
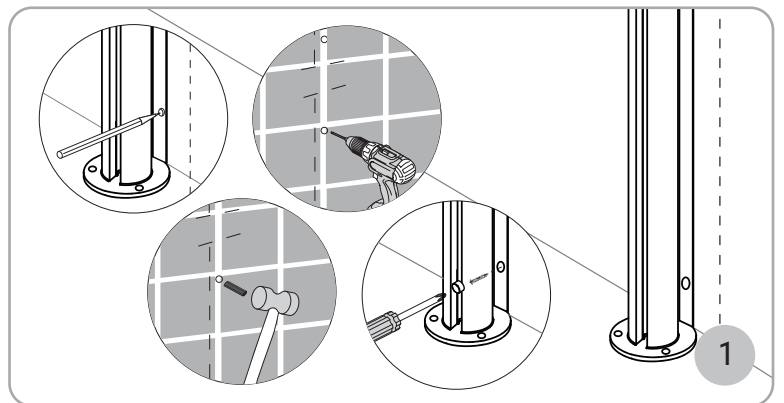
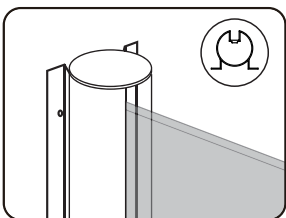
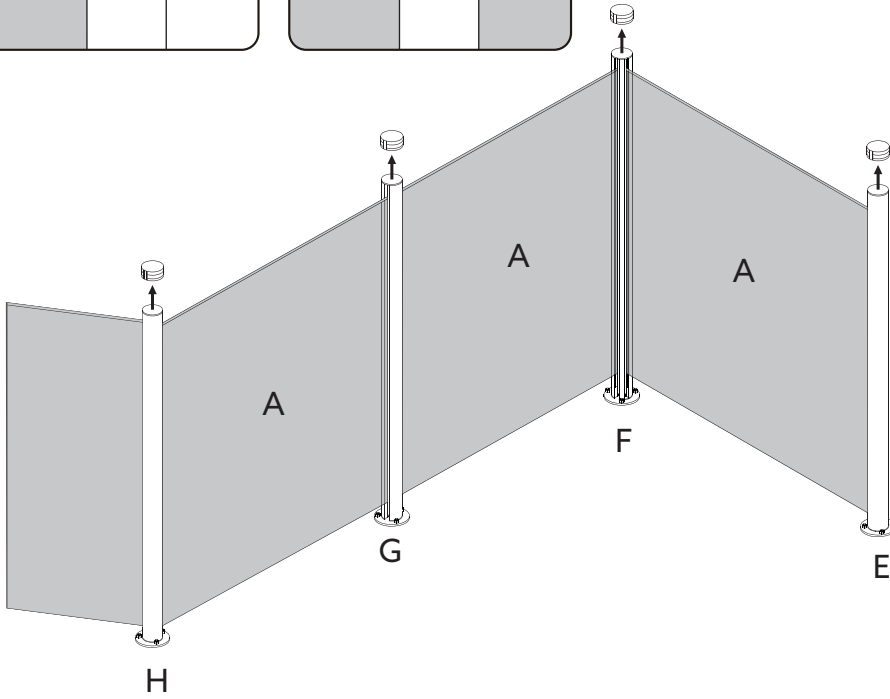
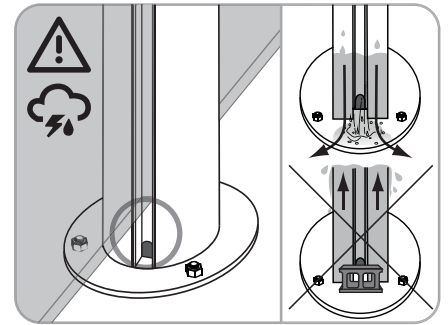
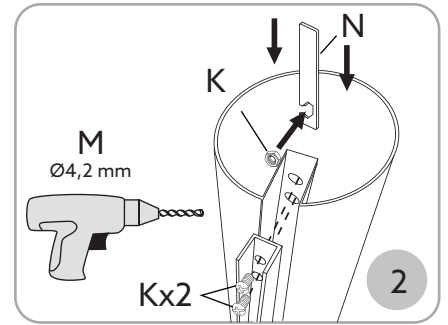
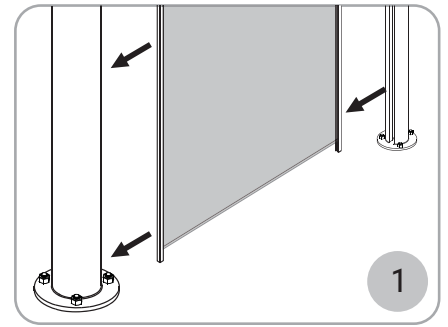
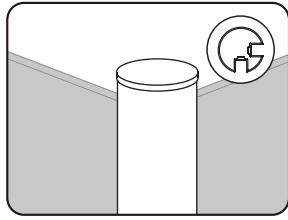
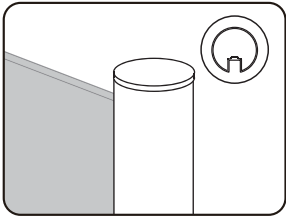
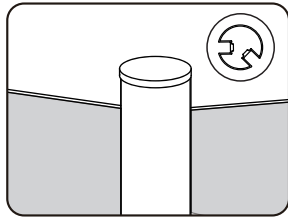
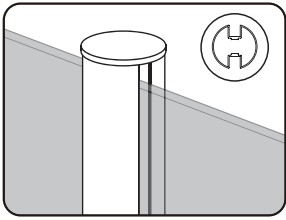

Råd om pleje

Glas

- Glasset skal rengøres som almindeligt glas.
- Brug et almindeligt middel til vinduespudsning, rigeligt med vand og en blød, fnugfri klud eller gummiskraber.
- Husholdningssprit eller acetone kan opløse vanskelige pletter. Sidol, Häxan, Brillo eller et andet skånsomt pudsemiddel kan polere andre vanskelige pletter væk. Pudsemidlet fjernes med husholdningssprit. Vask derefter glasset som normalt.
- Undlad at anvende skraber, metalgenstande eller ståluld til at fjerne vanskelig snavs.
- Metalaflejringer, som eventuelt ligner ridser, fjernes med en svag syre, f.eks. 5-10 % saltsyre. Gælder kun for energiglas.

Aluminiumprofiler

- Anvend mild sæbe, opvaskemiddel eller blot almindeligt vand er tilstrækkeligt til at rengøre profiler.
- Fjern snavs, der kan forvolde skade på sporprofiler og hjul.
- I tilfælde af farveaflejring fra gummislisten på profiler og skelet anvendes limfjerner til rengøring.

OBS! For at undgå personskaade og fuglekollisioner anbefaler vi, at f.eks. vores glas dekorationer "rovfugl" eller "svale" anvendes på alle glasoverflader.

